

**Tower Crane
Grue à tour**

Turmdrehkran 63 K



LIEBHERR

36,6 m (3 Turmstücke) Tower section
39,0 m (4 Turmstücke) Élément de mât

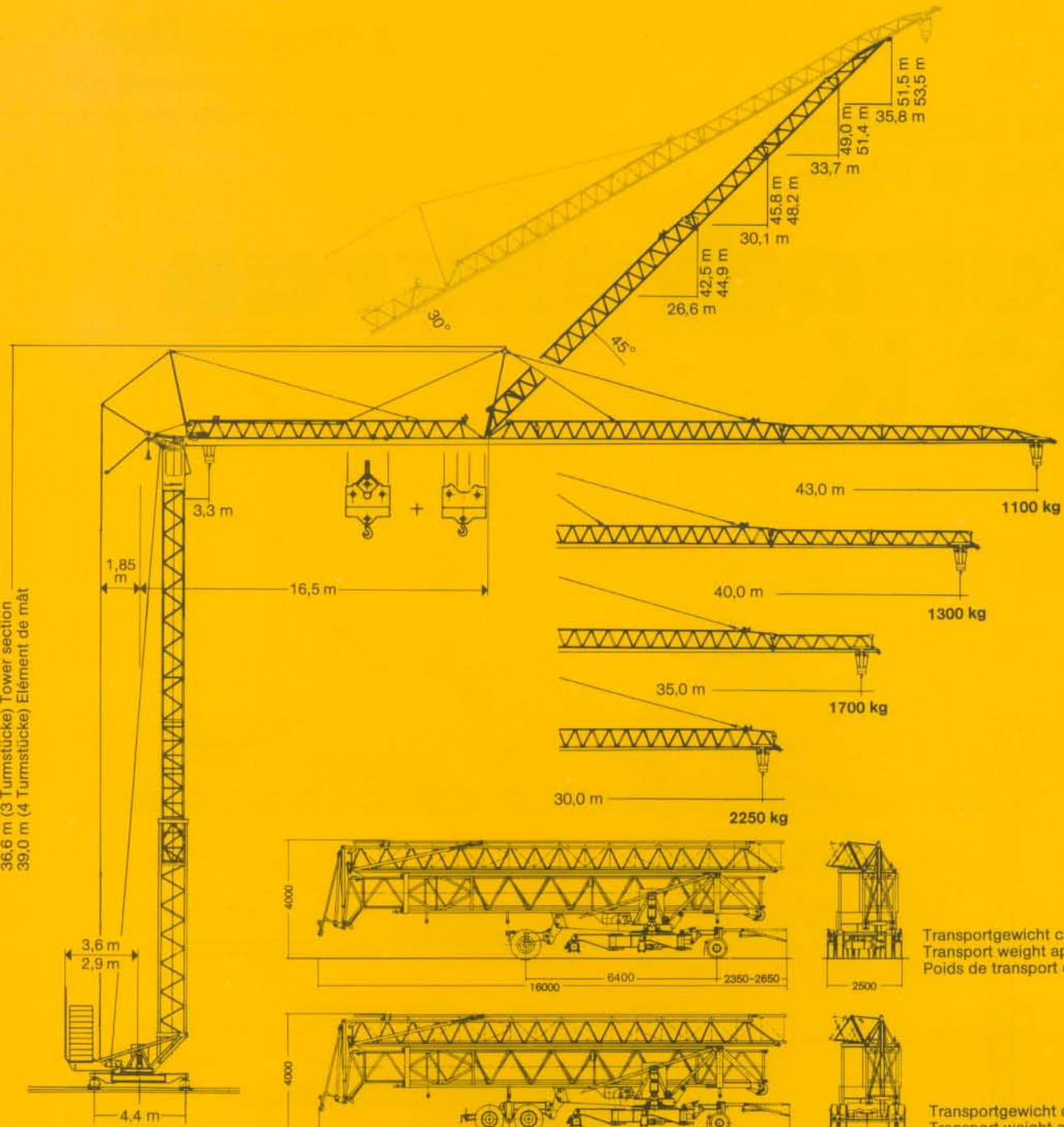

Gewicht

Weight

Poids

Max. Eckkraft in Betrieb Max. corner pressure in operation Réaction maxi. par angle en service	298 kN*
Max. Eckkraft außer Betrieb Max. corner pressure out of operation Réaction maxi. par angle hors service	200 kN*

Gegengewicht ca. Counter weight approx. Contrepoids env.	r = 3,6 m r = 2,9 m	26000 kg 34000 kg
Konstruktionsgewicht (max. Ausladung + Hakenhöhe) ca. Dead weight (max. radius + hook height) approx. Poids de la construction (max. portée + hauteur sous crochet) env.		18800 kg





* Umrechnung der Einheiten für Kräfte 1 kp ≈ 10 N; 10 kN ≈ 1 Mp./Conversion of the units for forces./Conversion des unités des forces.

63 K

Ausladung und Tragfähigkeit





Radius and capacity / Portée et charge

Auslegerlänge Length of jib Longueur de flèche m	max. kg m/kg		m/kg																				
			19,0	20,0	22,0	24,0	26,0	28,0	29,0	30,0	31,0	32,0	33,0	34,0	35,0	36,0	37,0	38,0	39,0	40,0	41,0	42,0	43,0
43,0	3,3-19,5 3050		3050	2970	2640	2380	2160	1970	1890	1800	1740	1670	1610	1550	1490	1440	1390	1350	1300	1260	1220	1180	1150
40,0	3,3-20,6 3050		3050	3050	2810	2530	2300	2100	2010	1900	1850	1780	1720	1650	1590	1540	1490	1440	1390	1350			
35,0	3,3-21,7 3050		3050	3050	3050	2760	2510	2290	2200	2110	2030	1950	1880	1810	1750								
30,0	3,3-25,3 3050		3050	3050	3050	3050	2960	2710	2600	2500													

m	max. kg m/kg		m/kg																				
			11,0	12,0	14,0	16,0	18,0	20,0	22,0	24,0	26,0	28,0	30,0	32,0	34,0	35,0	37,0	38,0	39,0	40,0	41,0	42,0	43,0
43,0	3,3-19,5 3000		6000	5730	4700	3960	3410	3000	2650	2370	2140	1950	1750	1640	1510	1460	1350	1300	1260	1220	1170	1140	1100
40,0	3,3-20,6 3000		6000	6000	4970	4190	3620	3170	2810	2520	2280	2070	1900	1750	1610	1550	1440	1390	1340	1300			
35,0	3,3-21,7 3000		6000	6000	5370	4540	3920	3440	3050	2740	2480	2260	2070	1910	1760	1700							
30,0	3,3-23,3- 3000		6000	6000	5800	4900	4240	3720	3310	2950	2690	2350	2250										

m	max. kg m/kg		Auslegersteilstellung 30° Elevated jib 30° Flèche inclinée 30° m/kg																				
			17,0	18,0	19,0	20,0	21,0	22,0	23,0	24,0	25,0	26,3	27,0	28,0	29,0	30,6	32,0	33,0	34,0	34,9	36,0	37,0	37,5
43,0	3,1-17,2 3050		3050	2890	2700	2540	2390	2260	2130	2020	1920	1800	1750	1670	1600	1490	1410	1360	1310	1260	1210	1170	1150
40,0	3,1-18,1 3050		3050	3050	2880	2700	2540	2400	2270	2160	2050	1900	1860	1780	1710	1590	1510	1450	1400	1350			
35,0	3,1-19,4 3050		3050	3050	3050	2950	2780	2620	2480	2360	2240	2110	2040	1950	1870	1750							
30,0	3,1-22,3 3050		3050	3050	3050	3050	3050	3050	2940	2790	2660	2500											

Geschwindigkeiten Speeds / Vitesses

	U/min 0 - 0,8 sl./min tr./min	3,0 kW
	20,0 / 40,0 m/min	1,5 / 2,2 kW
	25,0 m/min	2 x 1,5 kW
	0-45° ca. 60 sec.	4,0 kW

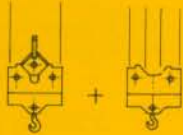
Hubwerk Hoist unit Mécanisme de levage	Stufe Step Cran	kg	m/min
15,6 kW 	1	3050	6,5
	2	3050	28,0
	3	1600	53,0
	1	3000 6000	6,5 3,25
	2	3000 6000	28,0 14,0
	3	1600 3200	53,0 26,5

Leitungsquerschnitt bei 380 V

Cross section of cable

Section de câble à

Betriebsspannung 380 V

Operating voltage

Tension de service

Technische Kenngröße nach BGL

Technical nominal size according to the construction machinery list (BGL)

Grandeur caractéristique suivant le barème d'emploi des appareils (BGL)

bis 99,0 m

up to

jusqu'à

Frequenz 50 Hz

Frequency

Fréquence

4 x 16 mm²

Anschlußwert 28,0 kVA

Power requirement

Puissance requise



2108-0063

Technische Daten - Technical data Caractéristiques techniques

Aufstellvorgang

Erection procedure

Déroulement de montage

Ballasterausladung 5,0 m

Ballasting radius 5,0 m

Portée pour dispositif de lestage 5,0 m

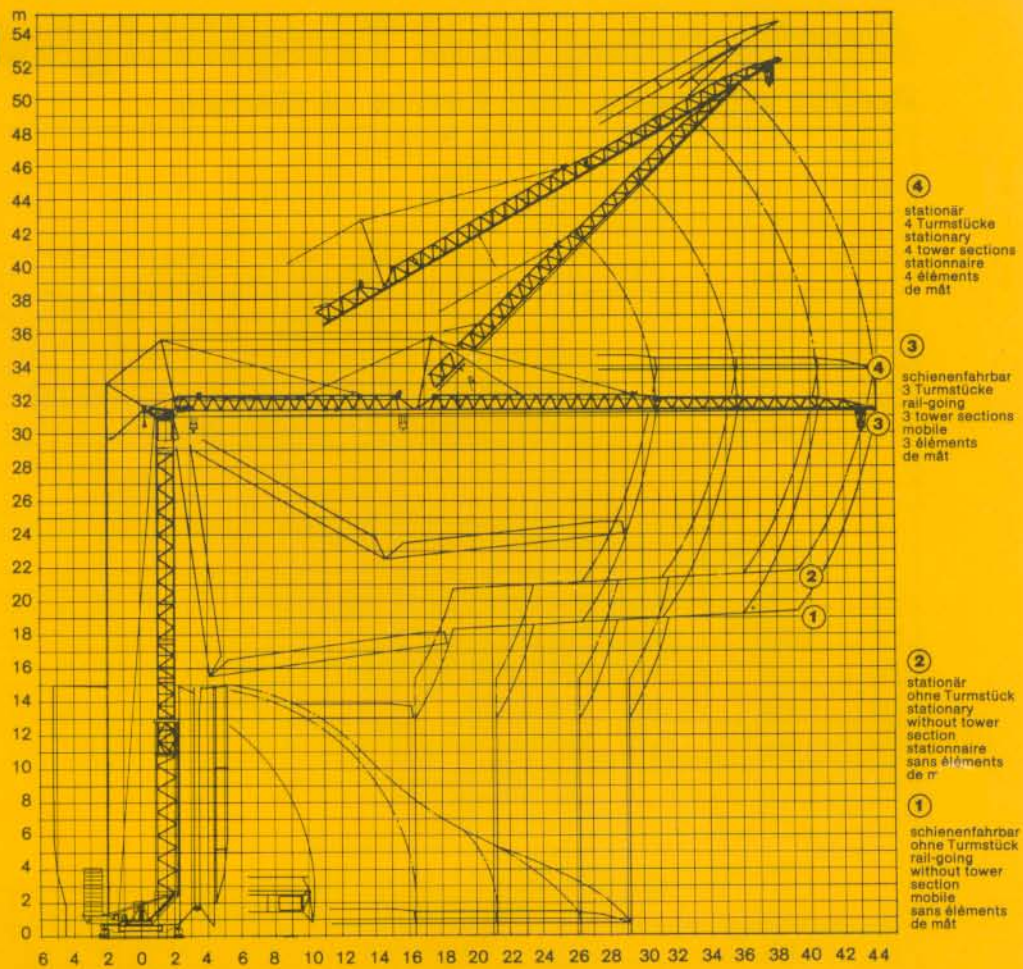

Kolli-Liste

Packing List

Liste de colisage

Pos. Item Rep.	Anz. Qty. Qté		L (m)	B (m)	H (m)	kg	
1	3	Turmstück (ohne Turmauflage) Tower section without tower support Élément de mât sans support de mât					450
2	1	Turmstück (mit Turmauflage) Tower section with tower support Élément de mât avec support de mât					550
3	1	Ausleger-Verlängerung 30,0 m – 35,0 m Jib extension Rallonge de la flèche					240
4	1	Ausleger-Verlängerung 35,0 m – 40,0 m Jib extension Rallonge de la flèche					180
5	1	Ausleger-Verlängerung 40,0 m – 43,0 m Jib extension Rallonge de la flèche					95
6	1	Transportachse vorne Tra 100 KY 1 Road transport axle front Essieux de transport avant					680
7	1	Transportachse hinten Tra 120 GY 1 Road transport axle behind Essieux de transport arrière					1200
8	1	Transportachse Tra 200 GZ 3 Road transport axle Essieux de transport					2500
9	1	Kiste mit Seilen und Kleinteilen Case with ropes and small parts Caisse avec câbles et pièces détachées					450

Datenblatt Nr. 120 P – 2501 H 1 B 3 DIN 15018 und OENORM T 3 • 04.94
Data sheet / Feuille de caractéristiques

Konstruktionsänderungen vorbehalten!
Subject to alterations! / Sous réserves de modifications!



+48 602 506 411
+48 602 684 577



Wielopole 141
33-311 Wielogłowy



lupher@lupher.pl
+48 (18) 440 06 40